

DESCRIPTION: 0.085 RIBBON - DIP SOLDER

	014	024	036	050
A	1.728	2.154	2.667	3.264
	43.90	54.70	67.75	82.90
B	0.992	1.417	1.925	2.624
	25.20	36.00	48.90	64.10
C	1.417	1.843	2.352	2.947
	36.00	46.80	59.74	74.85

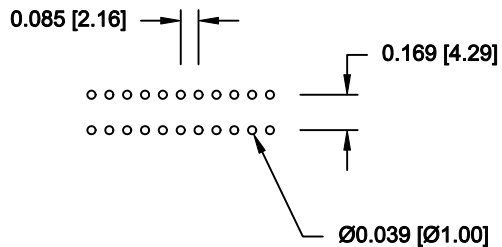
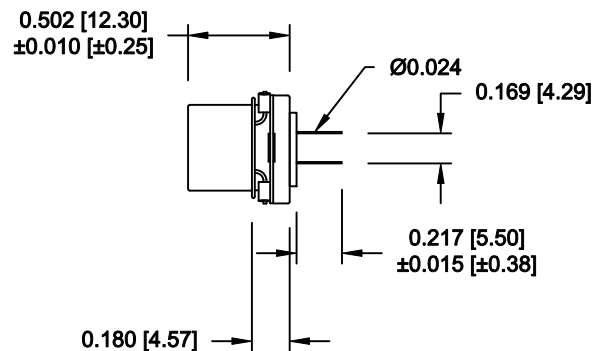
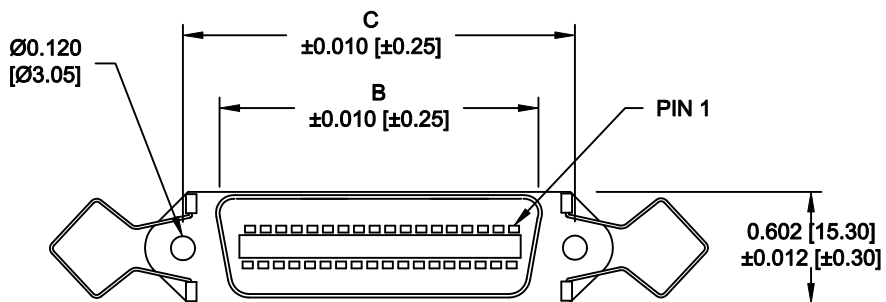
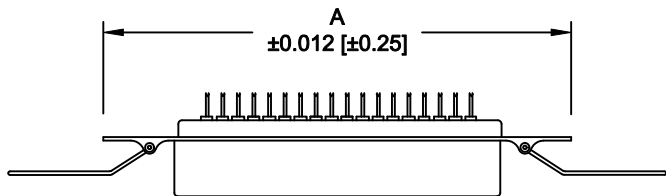

MATERIAL:

INSULATION: GLASS- FILLED THERMOPLASTIC
UL RATED 94V-0, 230°C PROCESS TEMP.
CONTACTS: COPPER ALLOY
CONTACT PLATING: GOLD FLASH IN THE MATING AREA
BRIGHT TIN IN THE SOLDER AREA
SHELL: STEEL, NICKEL PLATED

ELECTRICAL:

CURRENT RATING: 1 AMP
VOLTAGE RATING: 1,000V AC r.m.s.
INSULATION RESISTANCE: 1,000MegOhms Min. @ 500VDC
CONTACT RESISTANCE: 30MilliOhms Max.
OPERATING TEMPERATURE: -55°C TO +125°C

111-YYY-2 1 3 L 00 1

SERIES _____
POSITIONS _____
014 _____
024 _____
036 _____
050 _____
GENDER _____
2 = FEMALE
TERMINATION _____
1 = DIP SOLDER
RoHS COMPLIANT _____
L = LOW TEMP. PROCESS
SHELL PLATING _____
3 = NICKEL
HARDWARE _____
00 = NO HARDWARE
PLATING _____
1 = GOLD FLASH

DO NOT SCALE FROM DRAWING

RoHS COMPLIANT

	THESE DRAWINGS AND SPECIFICATIONS ARE THE PROPERTY OF NorComp AND SHALL NOT BE REPRODUCED, COPIED OR USED AS THE BASIS FOR THE MANUFACTURE OF SALE OF APPARATUS WITHOUT WRITTEN PERMISSION.	DRAWN: WAYNE ROBBINS CHECKED:	DATE: 09-15-05 DATE:
	<h1>NorComp</h1>	SCALE: NONE	SHEET 1 OF 2
DWG NO. 111-YYY-213L001			

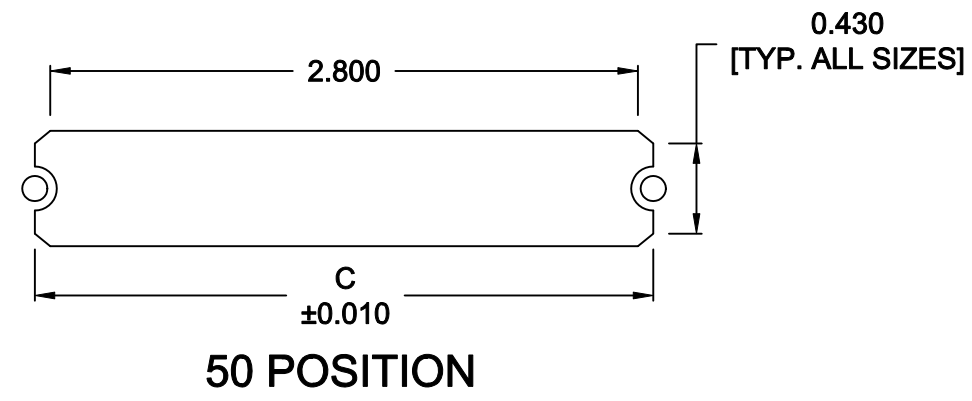
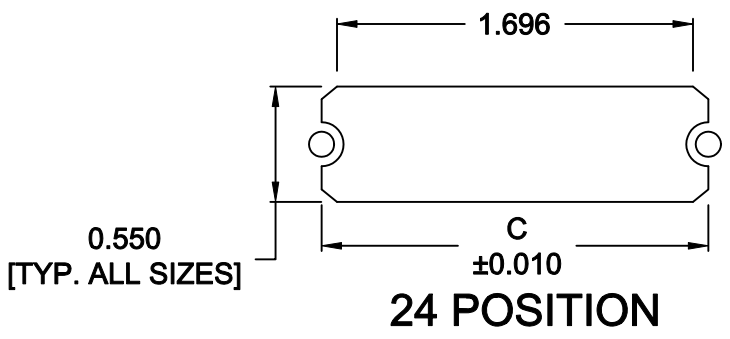
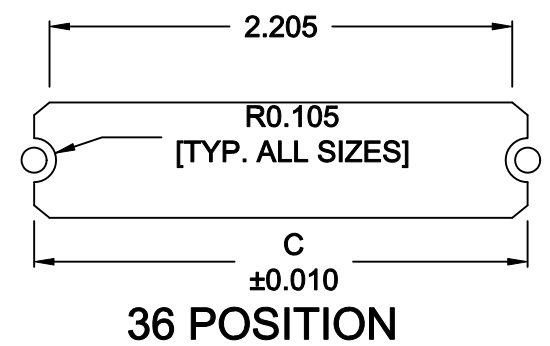
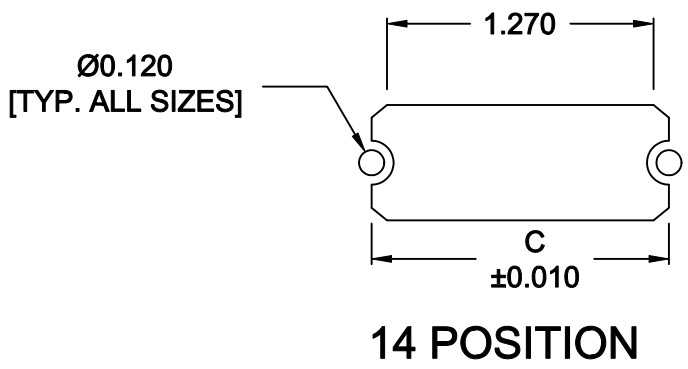

	014	024	036	050
C	1.417	1.843	2.352	2.947
	36.00	46.80	59.74	74.85



NOTE DIMENSION "C" =
 CENTER TO CENTER OF MOUNTING HOLES
 CENTER OF RADI
 OVERALL LENGTH OF CUTOUT

RoHS COMPLIANT

DO NOT SCALE FROM DRAWING

	THESE DRAWINGS AND SPECIFICATIONS ARE THE PROPERTY OF NorComp AND SHALL NOT BE REPRODUCED, COPIED OR USED AS THE BASIS FOR THE MANUFACTURE OF SALE OF APPARATUS WITHOUT WRITTEN PERMISSION.		DRAWN: M. SIGMON	DATE: 01-14-11
				CHECKED:
		SCALE: NONE	SHEET 2 OF 2	REV 9
		DWG NO. 111-YYY-213L001		