

DESCRIPTION: POWER - RIGHT ANGLE - MALE - MACHINED - IP67

**SPECIFICATIONS:**

**ELECTRICAL:**

INSULATOR RESISTANCE: 5 GΩ MIN.  
 DIELECTRIC WITHSTAND VOLTAGE: 1000 VAC FOR 1 MINUTE  
 WORKING VOLTAGE: 250V  
 OPERATING TEMPERATURE: -55°C TO +125°C  
 POWER CONTACT RESISTANCE: 2.0 mΩ MAX.  
 POWER CONTACT AMPERAGE: SEE P/N KEY

**MECHANICAL:**

CONTACT INSERTION FORCE: 4.5 Kg MAX.  
 CONTACT SEPARATION FORCE: 0.3 Kg MIN.

**MATERIALS:**

CONTACTS: COPPER ALLOY, GOLD FLASH  
 INSULATOR: PBT UL94V-0 RATED  
 230°C PROCESS TEMP.  
 SHELL: NICKEL PLATED STEEL  
 BRACKET: NICKEL PLATED STEEL  
 BOARD LOCK: NICKEL PLATED BRASS  
 SEAL: F08 FLEXIBLE ADHESIVE

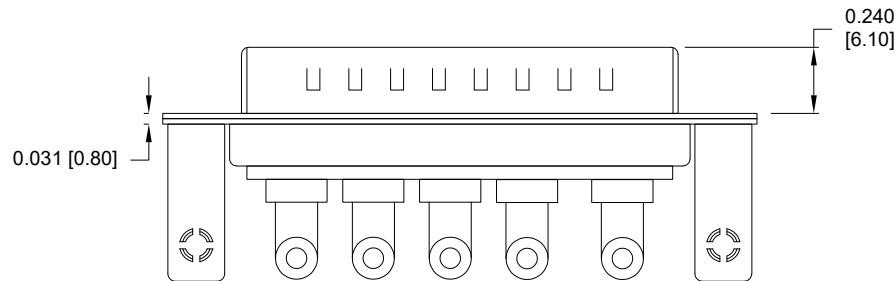
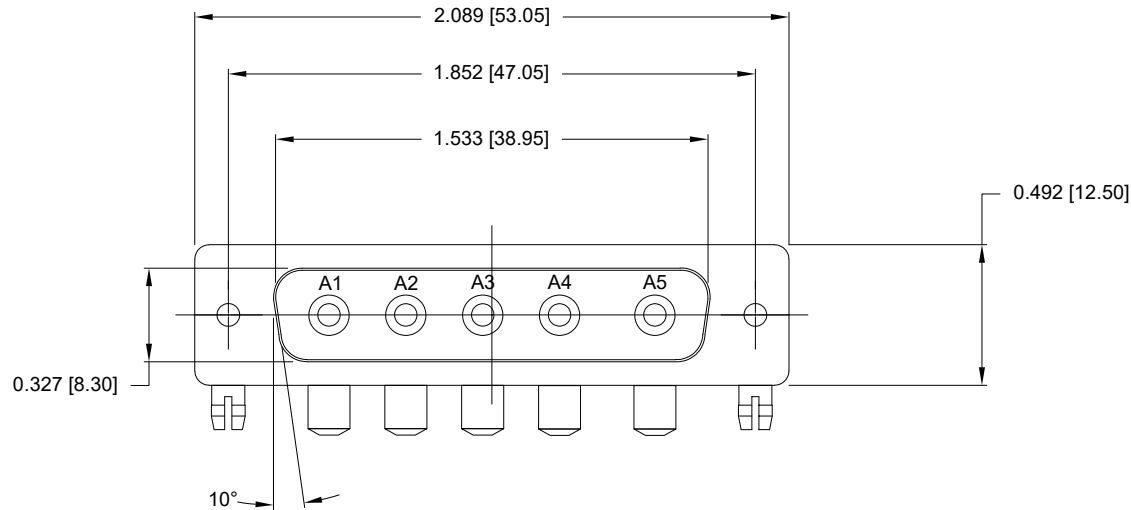

SEE SHEET 2  
FOR CONTACT & BRACKET DIMENSION DETAILS

**MEETS IP67 STANDARDS**

(SEE PAGE 3 FOR SEALING DETAILS)

**684S5W5103LYYY**

00 = 40 AMP POWER // NO BRACKET // STANDARD PCB TAILS  
 46 = 40 AMP POWER // #4-40 BRACKET // STANDARD PCB TAILS  
 62 = 40 AMP POWER // #4-40 BRACKET // 2.22mm PCB TAILS

1 = GOLD FLASH

**RoHS COMPLIANT**



THESE DRAWINGS AND SPECIFICATIONS ARE THE PROPERTY OF NorComp AND SHALL NOT BE REPRODUCED, COPIED OR USED AS THE BASIS FOR THE MANUFACTURE OR SALE OF APPARATUS WITHOUT WRITTEN PERMISSION.

DRAWN: M. SIGMON  
 DATE: 08/22/2011

UNITS = inches [mm]

**DO NOT SCALE FROM DRAWING**

**NorComp**

SCALE: NTS	SHEET 1	OF 3	REV 4
---------------	------------	---------	----------

DWG NO. **684S5W5103L461**

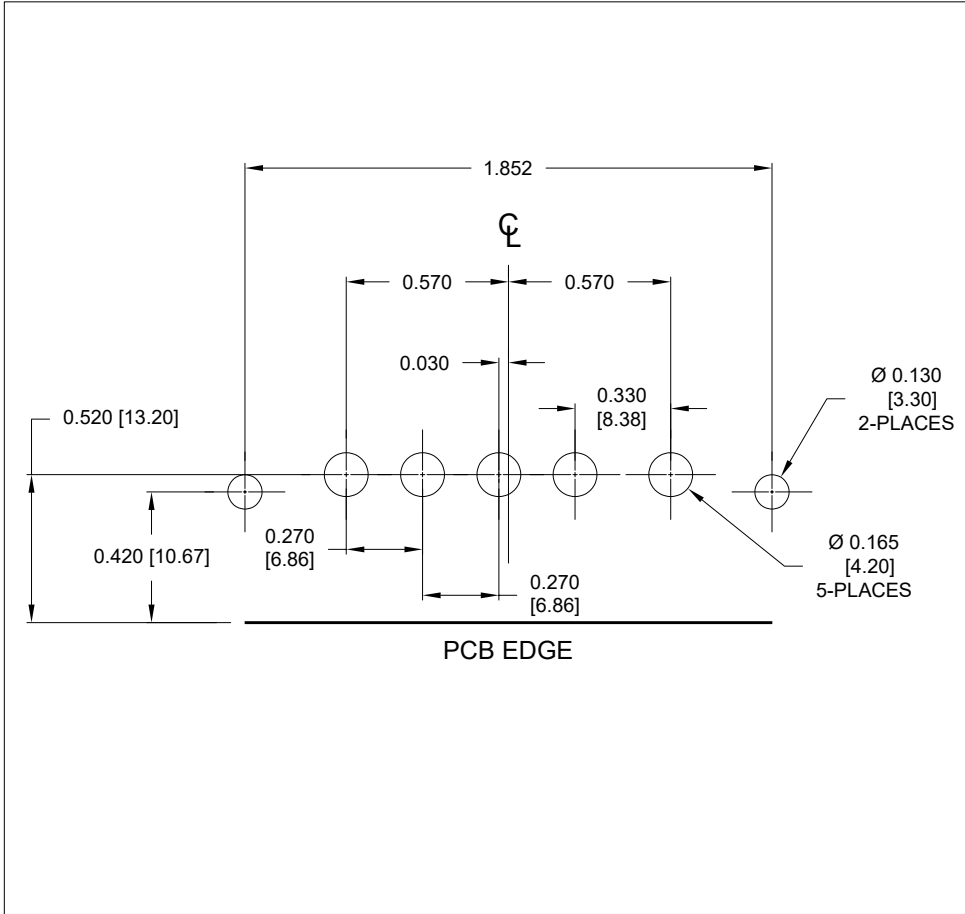

RIGHT ANGLE BRACKET

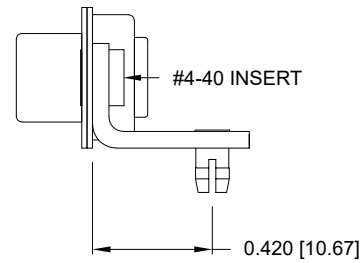

DIMENSIONS(in/mm)	
OPTION	P
46	0.185
	4.70
62	0.087
	2.22

POWER CONTACTS

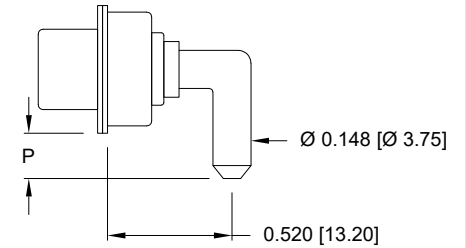

RoHS COMPLIANT

UNITS = inches [mm]

DO NOT SCALE FROM DRAWING



THESE DRAWINGS AND SPECIFICATIONS ARE THE PROPERTY OF NorComp AND SHALL NOT BE REPRODUCED, COPIED OR USED AS THE BASIS FOR THE MANUFACTURE OR SALE OF APPARATUS WITHOUT WRITTEN PERMISSION.

DRAWN:  
M. SIGMON

DATE:  
08/22/2011

NorComp

SCALE:  
NTS

SHEET 2 OF 3

REV 4

DWG NO.

684S5W5103L461

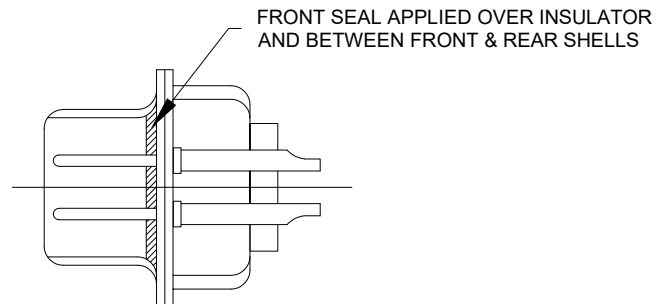
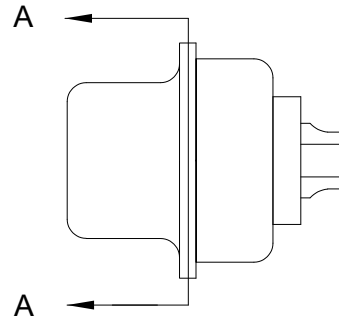

DETAIL A-A  
SHOWN FOR REFERENCE ONLY

RoHS COMPLIANT

UNITS = inches [mm] DO NOT SCALE FROM DRAWING



THESE DRAWINGS AND SPECIFICATIONS ARE THE PROPERTY OF NorComp AND SHALL NOT BE REPRODUCED, COPIED OR USED AS THE BASIS FOR THE MANUFACTURE OR SALE OF APPARATUS WITHOUT WRITTEN PERMISSION.

DRAWN:  
M. SIGMON

DATE:  
08/22/2011

*NorComp*

SCALE:  
NTS

SHEET 3 OF 3

REV 4

DWG NO.

684S5W5103L461