

SPECIFICATIONS:

MATERIALS:

HOUSING: PBT, UL94 V-0, BLACK
 SHELL: NICKEL PLATED STEEL
 HARDWARE: NICKEL PLATED BRASS

ELECTRICAL:

RATED VOLTAGE: 250V
 INSULATION RESISTANCE: 5 GOhms MIN.
 DIELECTRIC WITHSTANDING: 1,000 VAC r.m.s.

ENVIRONMENT:

OPERATING TEMPERATURE: -55°C TO +125°C

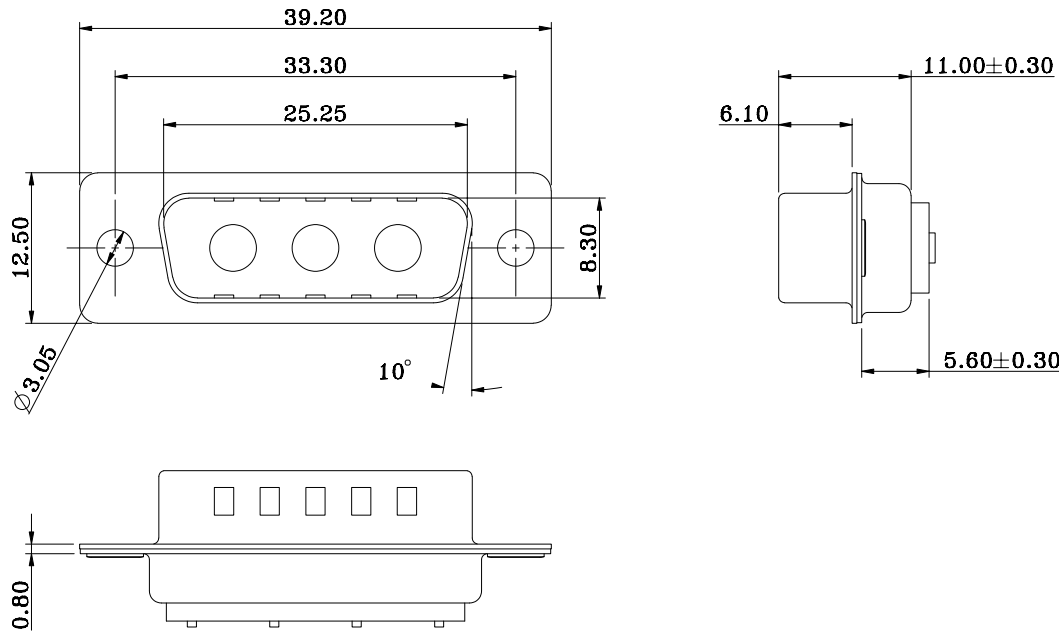

680M3W3173L0Y0

0 = NO HARDWARE
 1 = 2.5mm #4-40 CLINCH NUT PCB SIDE

SIGNAL AND POWER CONTACTS SOLD SEPARATELY
 (3x) POWER CONTACT P/N = 680M001-072LY0Y (Y = Place holder for variants)

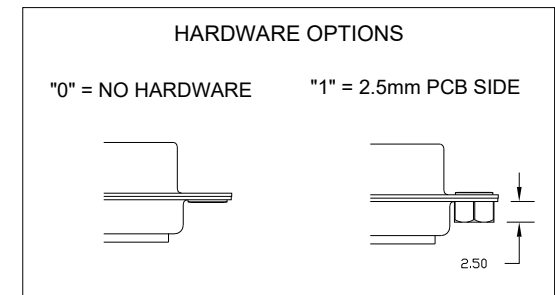

RoHS COMPLIANT

UNITS = mm

DO NOT SCALE FROM DRAWING



THESE DRAWINGS AND SPECIFICATIONS ARE THE PROPERTY OF NorComp AND SHALL NOT BE REPRODUCED, COPIED OR USED AS THE BASIS FOR THE MANUFACTURE OR SALE OF APPARATUS WITHOUT WRITTEN PERMISSION.

DRAWN:

J. KADEL

DATE:

11/16/2022

NorComp

SCALE:
NTS

SHEET 1 OF 1

REV 0

DWG NO.

680M3W3173L0Y0