

NOTE:

MATERIAL	
HOUSING:	PA66 UL94V-0, BLACK
CONTACT:	BRASS
NUT:	BRASS
O-RING:	EPDM, BLACK
FINISH	
CONTACT:	10u" GOLD PLATED
NUT:	NICKEL
ELECTRICAL	
RATED CURRENT:	4A
RATED VOLTAGE:	250V
INSULATOR RESISTANCE:	100 MΩhms MIN.
CONTACT RESISTANCE:	10 mΩhms MAX.
WATER PROOF:	IP67
ENVIRONMENT	
OPERATION TEMPERATURE:	-40°C TO +85°C
MAX WIRE AWG:	22 AWG

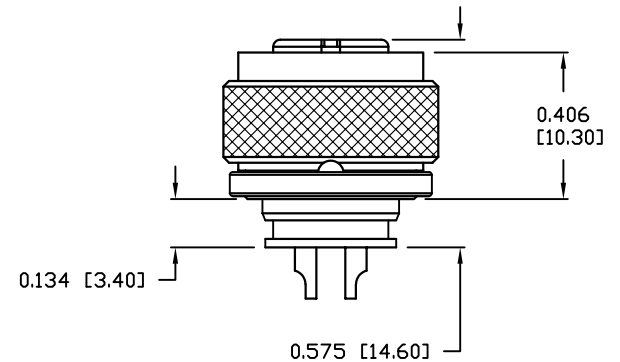
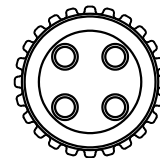
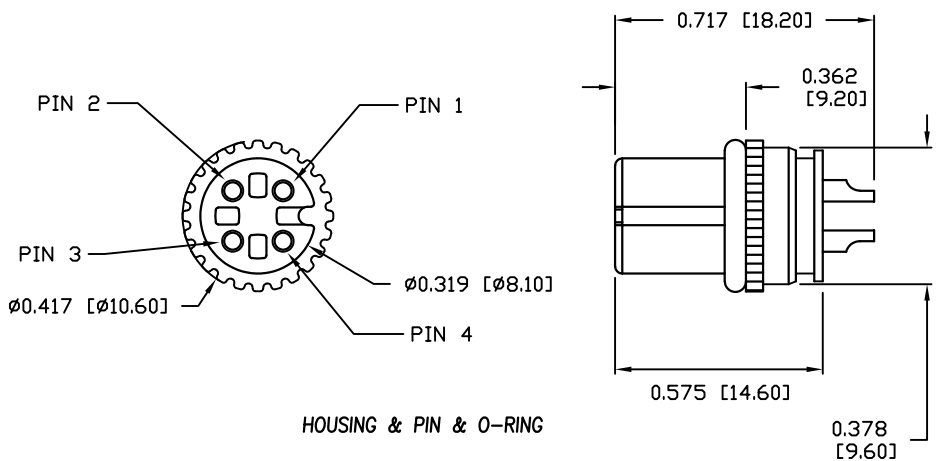

PLEASE NOTE THAT THE ANTI-VIBRATION DETENT IS MADE FROM PLASTIC AND IS NOT DESIGNED TO WITHSTAND MATING AND UN-MATING CYCLING; THIS WILL RESULT IN FAILURE OF THE ANTI-VIBRATION DETENT

RoHS COMPLIANT

UNITS = inch [mm]

DO NOT SCALE FROM DRAWING



THESE DRAWINGS AND SPECIFICATIONS ARE THE PROPERTY OF NorComp AND SHALL NOT BE REPRODUCED, COPIED OR USED AS THE BASIS FOR THE MANUFACTURE OR SALE OF APPARATUS WITHOUT WRITTEN PERMISSION.

DRAWN:
M. SIGMON

DATE:
08/04/2016

NorComp

SCALE:
NTS

SHEET 1 OF 1

REV 4

DWG NO.

858VA04-203RLU4