

DESCRIPTION: QUICK RELEASE - DIE CAST

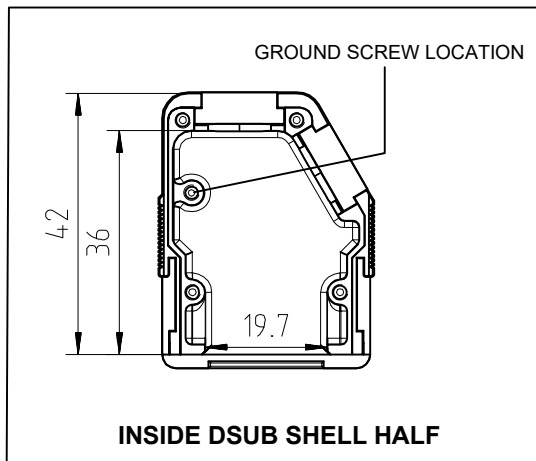

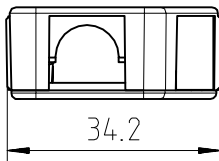
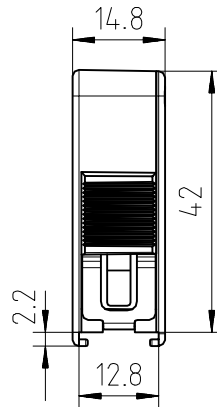
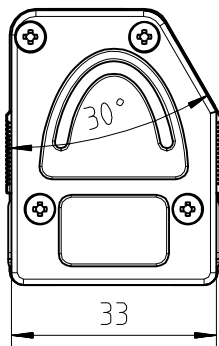
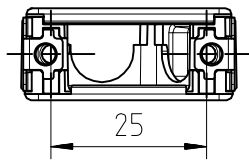

INSIDE DSUB SHELL HALF

SPECIFICATIONS:

MATERIAL: ZINC ALLOY, ZAMAK Z0410
TEMP RATING: -40°C to +90°C

BACKSHELL KIT INCLUDES:

- (2) BACKSHELL HALVES
-  (4) MOUNTING SCREWS // M2.5
-  (1) GROUNDING SCREW // M2.5
-  (1) BLIND PLATE/PLUG

955-009-030R121

SERIES _____
 POSITIONS _____
 009
 MATERIAL _____
 030 = DIE CAST
 COLOR _____
 12 = METAL(IZED)
 PUT-UP _____
 1 = KIT

**ADDITIONAL CABLE CLAMP ORDERED SEPARATELY
SEE NORCOMP PRODUCT PAGE - PART #955-09-SR-4-7**

RoHS COMPLIANT



THESE DRAWINGS AND SPECIFICATIONS ARE THE PROPERTY OF NorComp AND SHALL NOT BE REPRODUCED, COPIED OR USED AS THE BASIS FOR THE MANUFACTURE OR SALE OF APPARATUS WITHOUT WRITTEN PERMISSION.

DRAWN:
J. F. KADEL

DATE:
11/11/2022

UNITS = mm

DO NOT SCALE FROM DRAWING

NorComp

SCALE: NTS	SHEET 1	OF 1	REV 0
---------------	------------	---------	----------

DWG NO. 955-009-030R121