

SPECIFICATIONS:

MATERIALS:

HOUSING: PBT, UL94 V-0
 CONTACTS: GOLD FLASH PLATED BRASS
 SHELL: TIN PLATED STEEL

ELECTRICAL:

RATED CURRENT: 3A
 WORKING VOLTAGE: 250V
 INSULATION RESISTANCE: 1000 MOhms MIN.
 CONTACT RESISTANCE: 15 mOhms MAX.

ENVIRONMENT:

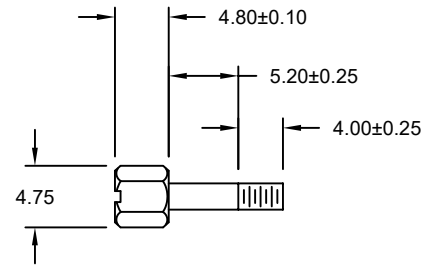
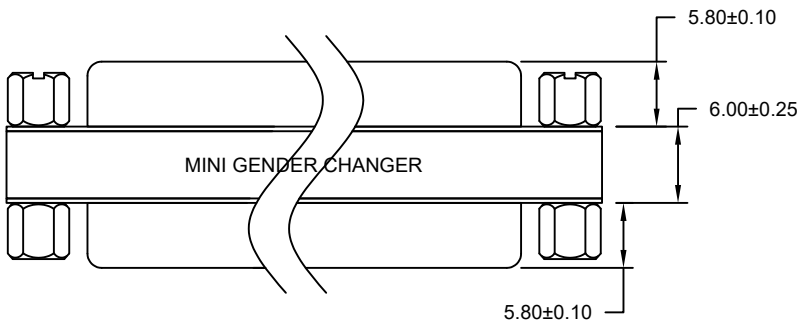
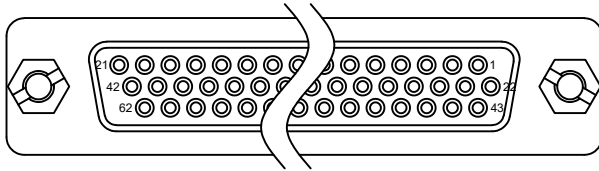

OPERATING TEMPERATURE: -55°C TO +105°C

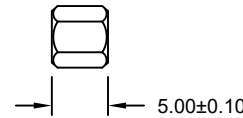
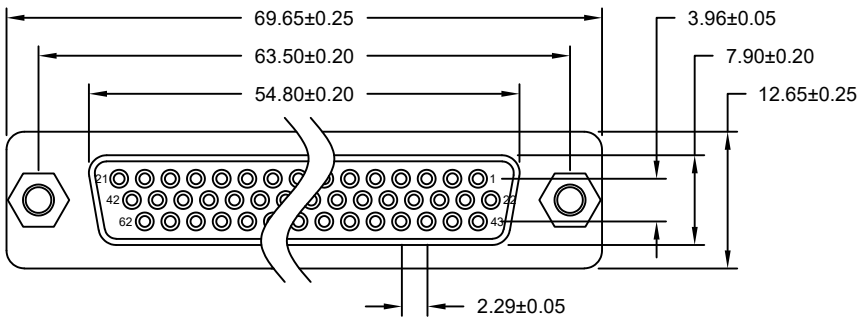

UNC #4-40 HEXSCREW (INTERNAL & EXTERNAL THREADS)



UNC #4-40 HEXNUT (INTERNAL THREADS)

62-PIN FEMALE	62-PIN FEMALE
1	1
2	2
3	3
	
61	61
62	62
SHELL	SHELL
	
PIN OUT	

RoHS COMPLIANT

UNITS = inch [mm]

DO NOT SCALE FROM DRAWING



THESE DRAWINGS AND SPECIFICATIONS ARE THE PROPERTY OF NorComp AND SHALL NOT BE REPRODUCED, COPIED OR USED AS THE BASIS FOR THE MANUFACTURE OR SALE OF APPARATUS WITHOUT WRITTEN PERMISSION.

DRAWN:

C. SMITH

DATE:

10/12/2007

NorComp

SCALE:

NTS

SHEET

OF

1

1

REV

4

DWG NO.

GCHDLP62F62F